

# Data Sheet



Article number: 0111022

Description: Retaining ring G 9

## Measures

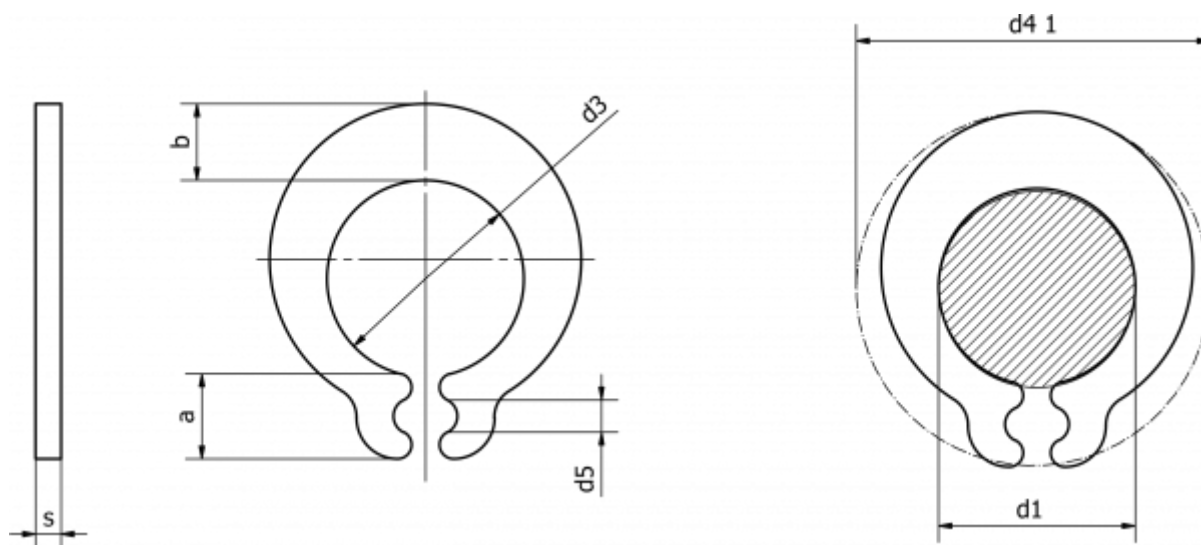

a max	= 4.7	n abl x 1000	= 46
b	= 3.3	s	= 1.20
d1	= 9.0	tol	= 0.090
d3	= 8.65	Tong	= ZGG-2
d4 1	= 18.6	Weight kg/1000	= 0.808
d5 min	= 2.0		
Description	= G 9,0		
Holding force N	= 230		